



STELLAR WORKS



BESPOKE BOOK

 STELLAR WORKS  
BESPOKE



## Stellar Works Bespoke

Stellar Works Bespoke is the result of the incorporation of founders from Japan and France, specialising in the production of bespoke furniture for hospitality and commercial projects. Stellar Works Bespoke deals with the fascinating and complex world of contract furnishing projects from niche boutique projects to large hospitality projects aspiring to be the best of the best in producing exclusive and quality furniture.

We constantly strive to fine-tune & strengthen our technical know-how and managerial skills through our co-operation with the world's most important hotel brands/groups, interior designers, procurement agencies, developers and owners in the execution of national and international projects. As a result, Stellar Works Bespoke over time has earned a position of excellence which extends beyond the hotel sector through to restaurants and luxury villas.

Using our knowledge and experience, we aspire to provide premier service focusing on quality, value and prompt delivery. We have specialist teams providing a range of services from quotations with value engineering (when required), production of construction drawings based on design intent, integral feedback from our technical experts, material sample preparation, production schedules, manufacture of prototypes and mass production up to shipment arrangement. Stellar Works Bespoke not only manufacture high quality products but provide assistance over all aspects from planning to the after sales assistance.



## Committed to Craftsmanship & Service

Stellar Works Bespoke, through the direction from our dedicated craftsman seeks to provide consistent premium quality design, and on schedule service within the competitive hospitality market.

## Our Factory

Stellar Works Bespoke, headquartered in Shanghai has a long standing joint venture with LAVAL, one of France's most renowned and well-established luxury furniture makers. The advantages of the Shanghai material environment and strategic location, combined with the benefit of more than 120 years of LAVAL production experience means that since 2008 we have been able to broaden our capabilities in production to cater for large scale projects.





## Quality and Craftsmanship

At Stellar Works Bespoke, we are completely committed to quality. The company employs highly professional teams of local craftspeople and foreign technicians from Japan, France and Italy. This unique set-up ensures the highest quality of woodcraft, upholstery and leatherwork, in addition to exceptional craftsmanship in decoration and lacquer techniques.



## World Class Upholstery

Stellar Works Bespoke have spent the past 8 years developing the upholstery foam that meets with all International regulations; whichever country our projects are located.

This foam development has been based on a leading French foam manufacturer's technology; making them resilient than standard foam products, guaranteeing longevity even in the toughest hospitality environments.



## Material Standard & Sustainability

- Japanese 4-Star sustainability rating for glue, paint, MDF & plywood
- FSC Grade timber
- Precision cut, superior quality dowels and anti-stain gliders imported from Japan
- All fabrics having a minimum of 40,000 to 130,000 abrasions (Martindale)
- 126 years of French upholstery expertise & experience
- British standard BS 5852 fire-retardant foam
- Custom fabric production capabilities
- Custom designed packaging to ensure protection
- Hardware selection supplied by Lamp, Blum, Hettich and Hafele
- Factory operating system Labo Pro developed by French partners

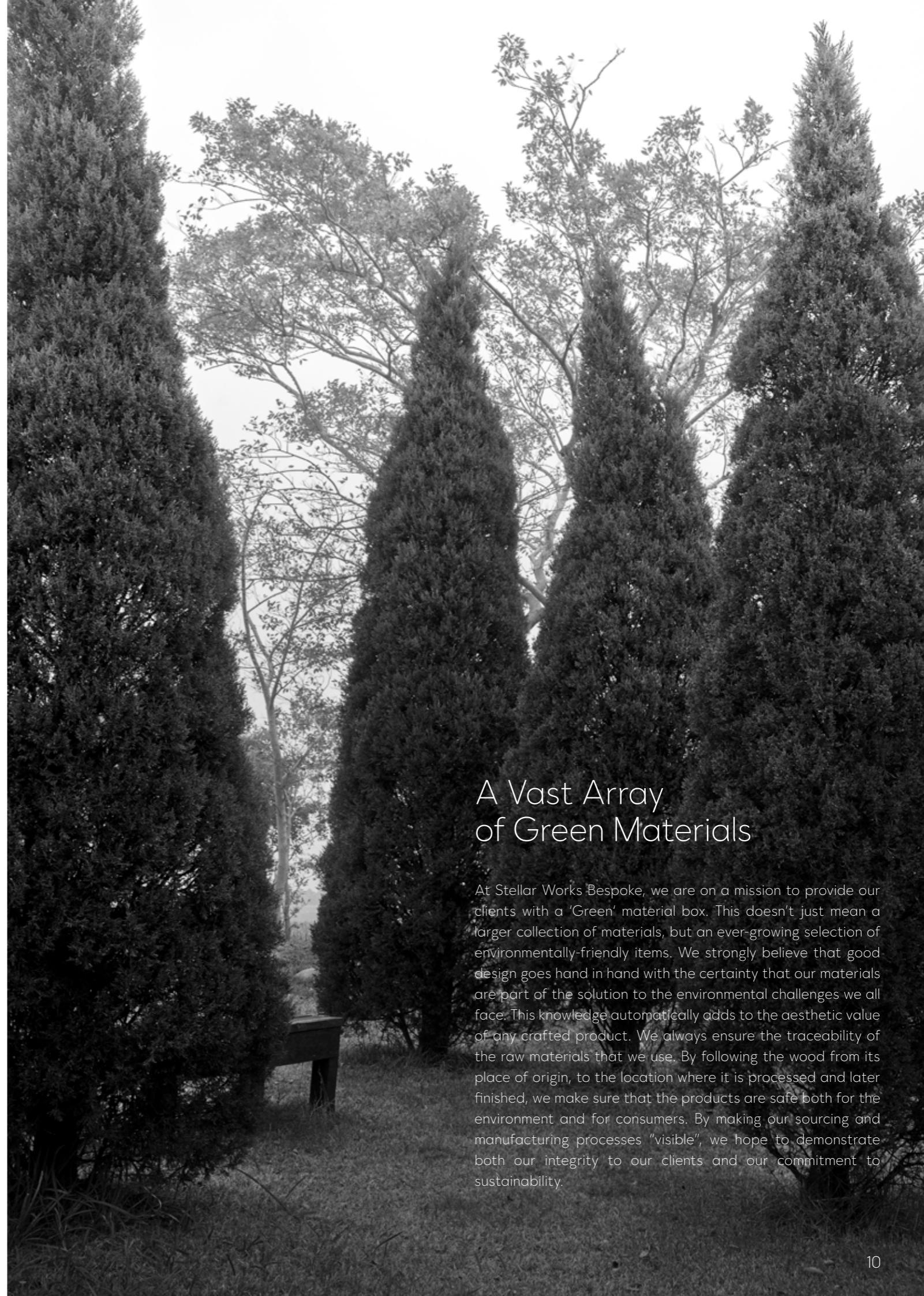

## A Vast Array of Green Materials

At Stellar Works Bespoke, we are on a mission to provide our clients with a 'Green' material box. This doesn't just mean a larger collection of materials, but an ever-growing selection of environmentally-friendly items. We strongly believe that good design goes hand in hand with the certainty that our materials are part of the solution to the environmental challenges we all face. This knowledge automatically adds to the aesthetic value of any crafted product. We always ensure the traceability of the raw materials that we use. By following the wood from its place of origin, to the location where it is processed and later finished, we make sure that the products are safe both for the environment and for consumers. By making our sourcing and manufacturing processes "visible", we hope to demonstrate both our integrity to our clients and our commitment to sustainability.



**Jacky Bogard**, France  
Woodwork/Upholstery



**Romaric Gauthier**, France  
Factory Operation



**Tsutomu Nomura**, Japan  
QA/QC Manager



**Shoichi Sakayama**, Japan  
Drawing



**Keiichi Suzuki**, Japan  
Woodwork



**Emmanuel Musso**, France  
Factory Operation



**Vito Stano**, Italy  
Senior Upholstery Manager



**Morgan Dervaux**, France  
Designer

## International Technicians

Stellar Works Bespoke are incredibly proud of our dedicated team of employees. We have best of French, Japanese and Chinese know-how. In addition to aspiring to be one of the most advanced and efficient factories you will see; we have brought together our leading technicians to work alongside the most qualified craftsmen in China.

As we constantly strive in our ability to make outstanding products in this very competitive market, we send our staff on regular technical exchanges to other furniture factories in both Japan and France. There, they learn to apply the latest advanced technology; improve their management skills and continue their growing passion for making furniture of the very highest quality.

SERVICE JOURNEY



Client Brief

1



Cost Calculation & Value Engineering

2



Proportion Development, Structural Engineering, Materials Development

3



Timeline Planning & Labo Pro System

4

Prototyping for quality standard

5

Mass Production

6



Photoshoot & QC Report

7



Packaging & Shipping

8

Delivery & Installation

9



Enjoy a work of art

10



## CLIENT BRIEFS

Whether the brief comes from an Architect, Interior Designer, Procurement company or Owner, we examine it thoroughly to ensure that every detail is clear and understood.

Our professionalism and experience ensures a comprehensive understanding of the client's requirements.

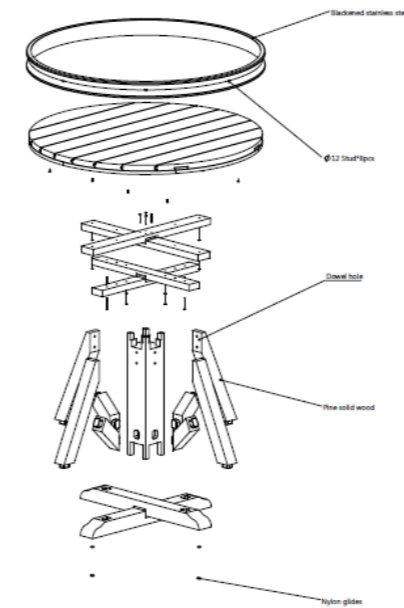

## DRAWINGS & ENGINEERING

Stellar Works use detailed construction drawings with SolidWorks 2-3D PDM (Produce Data Management) systems for technical engineering, and produce prototypes based on these drawings. Our team of specialists will then fine-tune the materials, details technicality and the processes required to deliver exactly what's required.



## PRELIMINARY DEVELOPMENT

At this preliminary stage, Quotations and value engineering will be discussed with clients. After confirmation of Quotation, preliminary drawings, material and colour samples are provided. Further technical and structural advice will be discussed with Designers for production drawings. These will all define the project specifications and will be referred to until the production is completed.

序号	规格名称	材料名称	数量	单位	备注	行号	单位	备注
1	不锈钢板	不锈钢板	120	0.50	25	2	1	1200x2400x0.50 304 不锈钢板
2	不锈钢管	不锈钢管	200	0.50	25	2	1	1200x2400x0.50 304 不锈钢管
3	不锈钢管	不锈钢管	120	0.50	25	2	1	1200x2400x0.50 304 不锈钢管
4	不锈钢管	不锈钢管	120	0.50	25	2	1	1200x2400x0.50 304 不锈钢管
5	不锈钢管	不锈钢管	120	0.50	25	2	1	1200x2400x0.50 304 不锈钢管
6	不锈钢管	不锈钢管	120	0.50	25	2	1	1200x2400x0.50 304 不锈钢管
7	不锈钢管	不锈钢管	120	0.50	25	2	1	1200x2400x0.50 304 不锈钢管
8	不锈钢管	不锈钢管	120	0.50	25	2	1	1200x2400x0.50 304 不锈钢管
9	不锈钢管	不锈钢管	120	0.50	25	2	1	1200x2400x0.50 304 不锈钢管
10	不锈钢管	不锈钢管	120	0.50	25	2	1	1200x2400x0.50 304 不锈钢管
11	不锈钢管	不锈钢管	120	0.50	25	2	1	1200x2400x0.50 304 不锈钢管
12	不锈钢管	不锈钢管	120	0.50	25	2	1	1200x2400x0.50 304 不锈钢管
13	不锈钢管	不锈钢管	120	0.50	25	2	1	1200x2400x0.50 304 不锈钢管
14	不锈钢管	不锈钢管	120	0.50	25	2	1	1200x2400x0.50 304 不锈钢管
15	不锈钢管	不锈钢管	120	0.50	25	2	1	1200x2400x0.50 304 不锈钢管

## PINPOINTING ELEMENTS

At this point we identify and prepare all of the specific elements being supplied for each area and for each purpose (Bedroom, Public Space, Restaurant etc) and also create BOM (Bill of Materials) for each of these individual areas.



### PROTOTYPING

Producing prototype is being able to touch, feel and see the real furniture and identifying any difficulties before the mass production. Therefore, prototyping is critically important and Stellar Works Bespoke can help to materialise the vision from drawings.



### PRODUCTION - WOOD JOINT

Joints are crucial to furniture construction and at Stellar Works Bespoke, we put emphasis on construction methods to create stability and strength for hospitality projects usage. We have professional Product Development and Technical Teams whom have experience in wood production for more than 20 year.



### LABO PRO SYSTEM

Our Labo Pro System is a workshop management system developed in France and translated in Chinese for our factory usage to track assembly procedures and traceability of components for each item and the precise timescale in which the materials will be prepared. This is a crucial stage in the ongoing monitoring work in progress.



### QUALITY CONTROL & PHOTOSHOOT

Quality Control is of critical importance at every stage. It begins with the selection of materials, continues throughout production and extends to the full-colour photography produced at our in-house studio. This means that the client knows what they're going to get and exactly what it looks like, before it even leaves the factory.

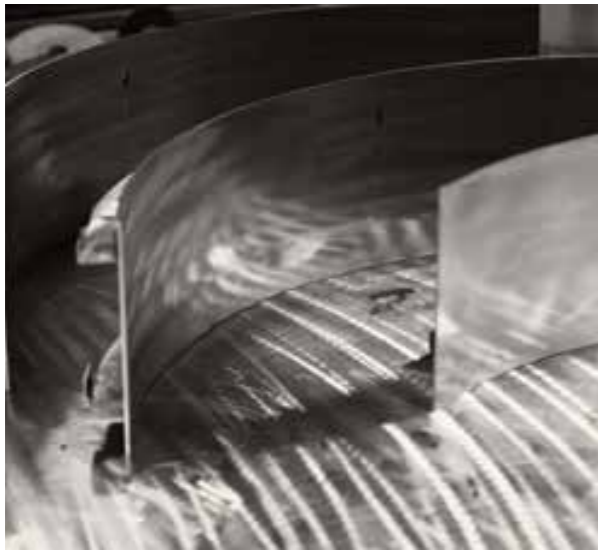

#### PRODUCTION - METAL WORKS

At Stellar Works Bespoke, our project uses various types of metal, such as iron, stainless steel and aluminum and we are capable to produce finishing like metal plating, brushed metal, buff polishing, sand blasting, powder coating and hot blackening. We ensure our quality control of metal production is on par with our standard quality of wood craftsmanship.



#### PRODUCTION - WATER BASED PAINT

When finishing furniture with any product, proper wood preparation is essential. Prep and sanding stages are as important as painting stages. In Stellar Works Bespoke, we use water-based paint that is less harmful to human and environment and release low level toxic emissions into the air for years after application. The low VOC paint reduced toxin level and benefits our clients who has skin allergies and chemical sensitivities.



#### PRODUCTION - UPHOLSTERY

Stellar Works Bespoke has a strong upholstery technique adopted from our 126 years experienced French factory Laval and we produce top range quality upholsteries. Although sewing seems to be a simple process, upholstery sewing is quite a complex process involving many preparations and mathematical calculations for the perfect seam quality. Good quality sewing also depends on the sound technical knowledge that goes into pattern designing and making.



#### PACKAGING & LOGISTICS

Products are individually packed in purpose-built protective cartons, with additional packing materials used for extra safety. All products are cleaned and handled with white gloves, to ensure every piece leaves in the perfect condition. Packages are clearly labeled using a logical numbering sequence that makes it simple for the on-site teams to identify and install pieces when they arrive. Great production is nothing without great delivery, so logistics is an area of paramount importance when working on international jobs. Our production line has a reliable, robust structure that enables it to guarantee the synchronization of manufacturing and dispatches, as well as supervision of assembly on sites right across the world.



#### **INSTALLATION**

We are able to provide installation service upon request.

Our global offices based in Europe, America, Asia and Oceania will be readily to provide the support of installation if required.



#### **AFTER-SALES SERVICE**

The mission of Stellar Works does not stop once the furnishing elements have been delivered and assembled, it continues with attentive after-sales service. Whether it is assistance with repairs or additions to existing projects, all requests are managed with the utmost consideration and professionalism, services are provided promptly and the continuity of the construction techniques and finish of the products is guaranteed.

## PROJECTS

HOTEL BRANDS WE HAVE WORKED WITH

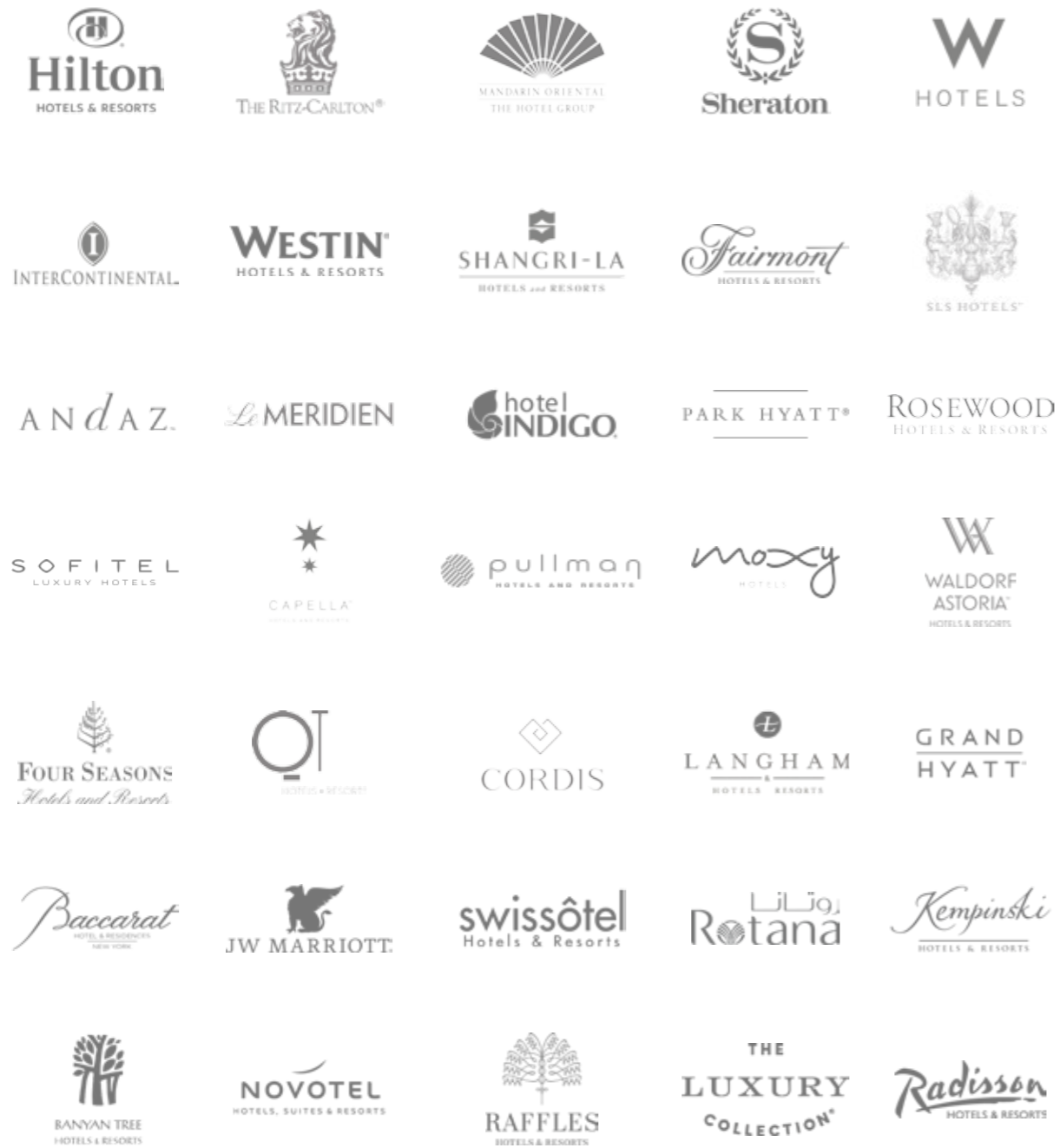

INTERNATIONAL HOTELS



## BACCARAT HOTEL NEW YORK, USA

Designer: Gilles et Boissier  
Stellar Works Bespoke x Ets Pierre Laval

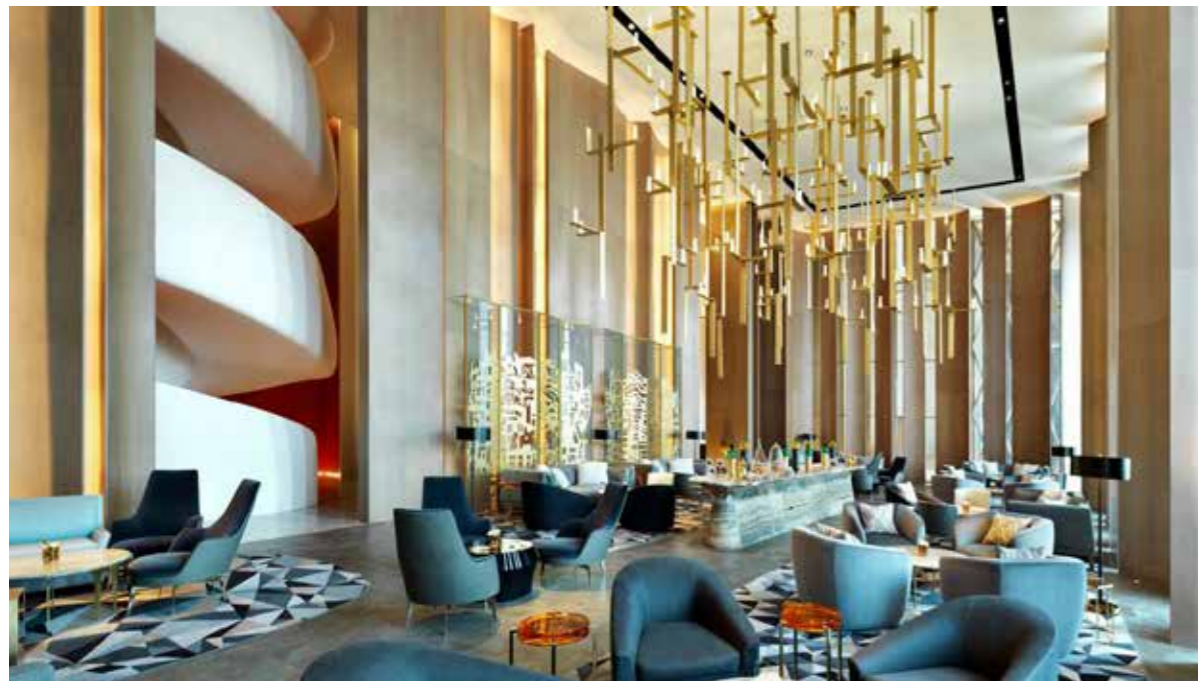
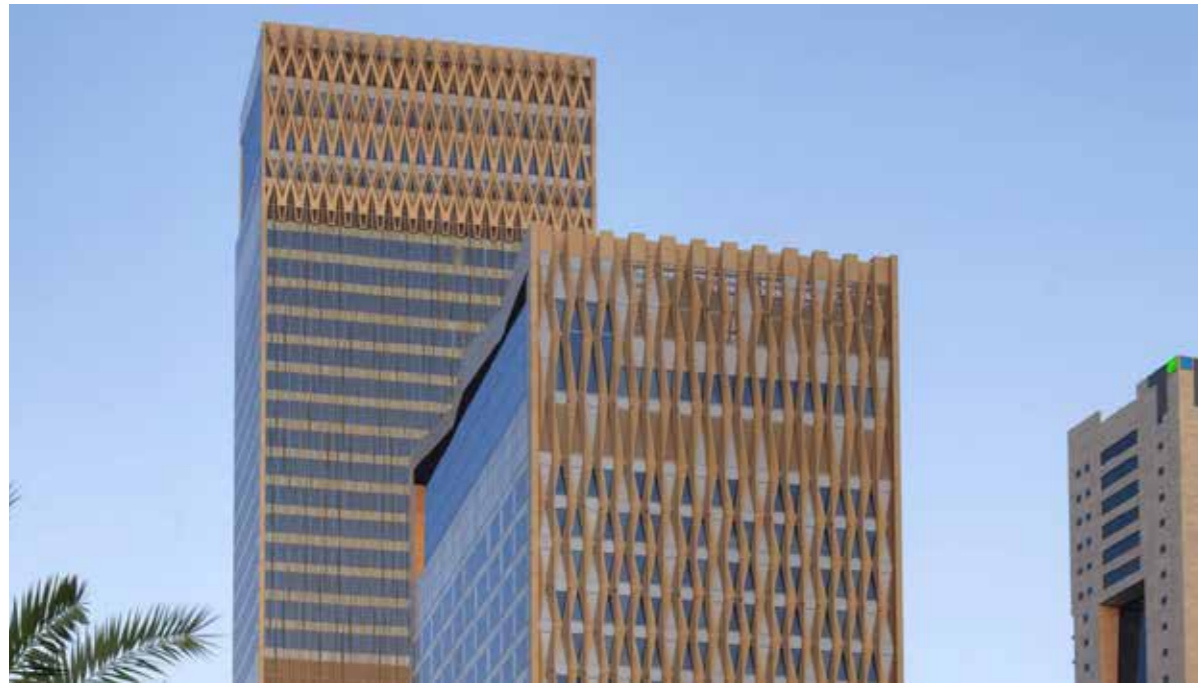

## FOUR SEASONS HOTEL KUWAIT

Designer: Yabu Pushelberg, Kokai Studio  
Stellar Works Bespoke x Ets Pierre Laval





PARK HYATT HOTEL  
SYDNEY, AUSTRALIA

Designer: Bar Studio



## SHANGRI-LA HOTEL PARIS, FRANCE

Designer: Pierre Yves Rochon  
Stellar Works Bespoke x Ets Pierre Laval



## BISHA HOTEL TORONTO, CANADA

Designer: Studio Munge



## LE ROYAL MONCEAU HOTEL PARIS, FRANCE

Designer: Philippe Starck  
Stellar Works Bespoke x Ets Pierre Laval



## MOXY, TIMES SQUARE NEW YORK, USA

Designer: Yabu Pushelberg



## SOUTH BEACH HOTEL SINGAPORE

Designer: Philippe Starck



# QT HOTEL SYDNEY, AUSTRALIA

Designer: Nicolas Graham (G+A)



# KEMPINSKI SUMMERLAND HOTEL & RESORT BEIRUT, LEBANON

Designer: Hirsch Bedner Associates (HBA)



## ROSEWOOD HOTEL PHNOM PENH, CAMBODIA

Designer: Bar Studio, BOND Design

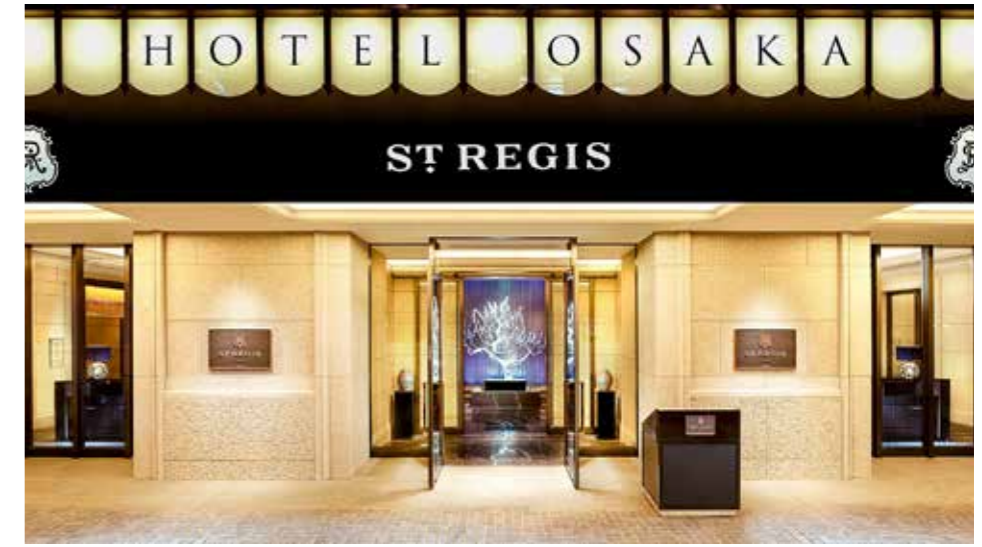

## ST. REGIS HOTEL OSAKA, JAPAN

Designer: GA Design



## LE MÉRIDIAN ETOILE PARIS, FRANCE

Designer: Michaelis Boyd Associates



## PENTHOUSE TED BAKER BOURNEMOUTH, ENGLAND

Designer: Scott Brownrigg



## FOURVIÈRE HÔTEL LYON, FRANCE

Designer: Julie Mathias



## MARRIOTT HOTEL COPENHAGEN, DENMARK

Designer: Helle Flou



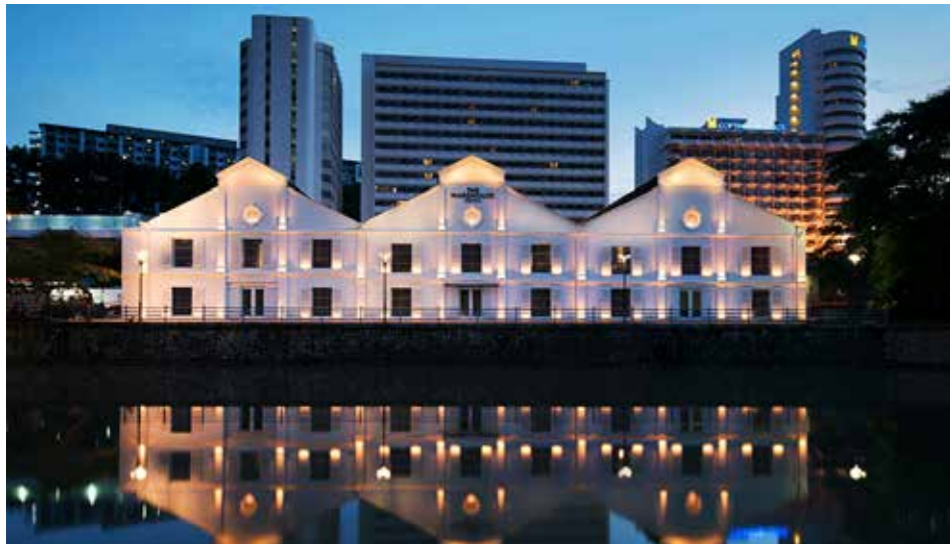

## WAREHOUSE HOTEL SINGAPORE

Designer: ASYLUM



## LANGHAM HOTEL LONDON, UK

Designer: Richmond Designing Hospitality



# CHAO HOTEL BEIJING, CHINA

Designer: BOEH Design



# CAPELLA HOTEL SHANGHAI, CHINA

Designer: JAYA Design



## BANYAN TREE HOTEL YANGSHUO, CHINA

Designer: Banyan Tree



## LE MÉRIDIEN HOTEL ZHENGZHOU, CHINA

Designer: Neri & Hu



## JERVOIS HOTEL HONG KONG, CHINA

Designer: Christian Liaigre  
Stellar Works Bespoke x Ets Pierre Laval



## ROSEWOOD HOTEL BEIJING, CHINA

Designer: Bar Studio



## SWATCH ART PEACE HOTEL SHANGHAI, CHINA

Designer: Patrick Jouin



## RITZ CARLTON HOTEL SHANGHAI, CHINA

Designer: Super Potato



ANDAZ HOTEL  
SHANGHAI, CHINA

Designer: Super Potato



GRAND HYATT HOTEL  
HONG KONG, CHINA

Designer: Bar Studio



## FOUR SEASONS PLACE SHANGHAI, CHINA

Designer: Yabu Pushelberg



## CORDIS HOTEL SHANGHAI, CHINA

Designer: LTW Designworks





## PULLMAN HOTEL KAIFENG, CHINA

Designer: LTW Designworks

RESTAURANTS



# NOMA COPENHAGEN, DENMARK

Designer: Space Copenhagen



# JEAN GEORGES SHANGHAI, CHINA

Designer: Neri & Hu



WEDGWOOD TEA ROOM  
STOKE ON TRENT, UK

Designer: Town Creatives



SONG QI  
MONTE CARLO, MONACO

Designer: Humbert & Poyet



## COMMUNITY SMITH ATLANTA, USA

Designer: Crème Design



## L'AMICO NEW YORK, USA

Designer: Crème Design



## SWIFT & SONS CHICAGO, USA

Designer: AvroKo



## UNION SQUARE CAFE NEW YORK, USA

Designer: David Rockwell



## GLASS HOUSE BOSTON, USA

Designer: Hacin & Associates



## CANTON TABLE SHANGHAI, CHINA

Designer: Neri & Hu



## JOEL ROBUCHON SHANGHAI, CHINA

Designer: Pierre-Tves Rochon  
Stellar Works Bespoke x Ets Pierre Laval



## HAKKASAN SHANGHAI, CHINA

Designer: GBRH  
Stellar Works Bespoke x Ets Pierre Laval



# SHAKE SHACK FLAGSHIP NEW YORK, USA

Designer: Crème Design



# STARBUCKS FLAGSHIP SEATTLE, USA

Designer: Starbucks Coffee Company





## SULWHASOO FLAGSHIP SEOUL, KOREA

Designer: Neri & Hu



## ROLEX STORE ROLL-OUT FOR ASIA PACIFIC

# Hotel Projects

## CHINA

Swatch Peace Hotel, Shanghai  
Cordis Hotel, Shanghai  
Ritz Carlton Hotel, Shanghai  
Andaz Hotel, Shanghai  
Capella Hotel, Shanghai  
Rosewood Hotel, Beijing  
Pullman Hotel, Kaifeng  
Chao Hotel, Beijing  
Four Seasons Place, Shanghai  
Jervois Hotel, Hong Kong  
Grand Hyatt Hotel, Hong Kong  
Banyan Tree Hotel, Yangshuo  
Le Meridien Hotel, Zhengzhou

## ASIA

Peninsula Hotel, Tokyo  
St. Regis Hotel, Osaka  
South Beach Hotel, Singapore  
Rosewood Hotel, Phnom Penh  
Intercontinental Hotel, Osaka  
Capitol Tokyu Hotel, Tokyo  
Warehouse Hotel, Singapore  
Cappucino Hotel, Seoul

## GCC

Four Seasons Hotel, Kuwait  
Kempinski Hotel, Beirut  
Park Hyatt Hotel, Doha  
Centro Rotana Hotel, Jeddah  
Mandarin Oriental, Dubai

## OCEANIA

Park Hyatt Hotel, Sydney  
W Hotel, Brisbane  
Westin Hotel, Sydney  
Four Seasons Hotel, Sydney  
QT Hotel, Sydney  
QT Hotel, Canberra  
QT Hotel, Perth  
QT Hotel, Queenstown

## NORTH AMERICA

Baccarat Hotel, New York  
11 Howard Hotel, New York  
Bisha Hotel, Toronto  
SLS Hotel, Miami  
One Hotel, New York  
Moxy Hotel, New York  
Peninsula Hotel, New York  
Viceroy Hotel, Chicago

## EUROPE

The Langham, London  
Le Royal Monceau Hotel, Paris  
Shangri-La Hotel, Paris  
Sofitel Hotel, Paris  
Le Meridien Etoile Hotel, Paris  
Fourviere Hotel, Lyon  
Lancaster Square Hotel, London  
Le Royal Evian, Lake Geneva, France

# Global Office

## ASIA

### China

1368 Lixue Road, Jiading District  
201801 Shanghai  
+ 86 2159513236  
info@stellarworks.com

### Japan

2-18-21 2F Jingumae  
Shibuya-ku, Tokyo  
+ 81 364555593  
info@stellarworks.com

## OCEANIA

### Australia

Shed 74, 4D Huntely Street  
Sydney NSW  
+ 61 296405606  
info@stellarworks.com

## NORTH AMERICA

### United States

38 Walker Street, New York  
NY 10013  
+ 1 6466063760  
info@stellarworks.com

## EUROPE

### Austria

+ 43 6767107704  
austria@nineunited.com

### Belgium / Lux

Hofstracat 24,  
Antwerpen 2000  
+ 32 499305638  
belgium@nineunited.com

### France

3 avenue du President Wilson,  
Paris 75016  
+ 33 145630429  
france@nineunited.com

### Germany

Fürstenwall 65, Düsseldorf 40219  
Auguststrasse 19, Berlin 10117  
+ 49 21131127800 / 3027593574  
germany@nineunited.com

### Italy

+ 39 3316614540  
italy@nineunited.com

### Netherlands

Aalsmeerderdijk 640,  
Rijsenhout 1435BW  
+ 31 297374747  
holland@nineunited.com

### Scandinavia

+ 45 23313486  
scandinavia@nineunited.com

### Spain & Portugal

C/Argelia 2,  
Malaga 29140  
+ 34 670066296  
spain@nineunited.com

### Switzerland

Feldeggstrasse 2,  
Glattbrugg 8152  
+ 43 06767107704  
switzerland@nineunited.com

### United Kingdom

34 Queen Anne's Gate,  
London SW1H 9AB  
+ 44 2072220574  
uk@nineunited.com



